



MOULDINGS & DOOR FRAMES

몰딩 & 도어 프레임

- 재고 운영 시트(인테리어 필름)
- 래핑몰딩운영가이드
- 래핑 몰딩
- 방염 래핑몰딩

- PVC 몰딩 & 백색 페이퍼 몰딩
- PVC 도어 프레임
- 도어 프레임

현장 작업이 용이한 인테리어 필름 | 연결필름 |

 방염인테리어 필름 재고운영





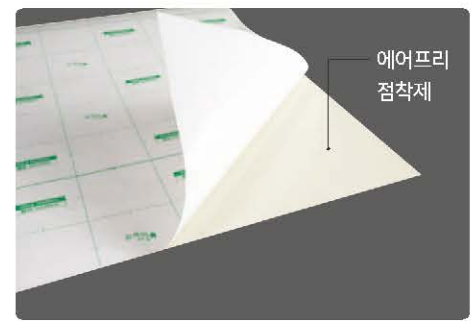



에어프리 인테리어 전용 필름 장점

현장 시공시 기포 발생을 최소화 해주고,
스퀴지 작업 시 접착제 뭉침현상을 완화해줍니다.
공기층을 빼면서 작업이 가능해
접착력을 높일 수 있습니다.







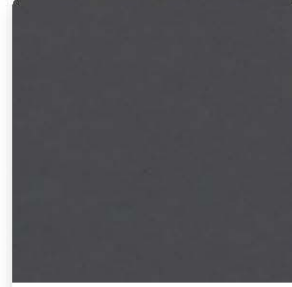



· 방염인테리어 필름으로 사용한 도어/문틀은 방염필증이 부착되지 않습니다.
· 방염 도어 시험성적서가 아닌 방염인테리어 필름에 대한 시험성적서만 교부 가능합니다.

재고운영 색상 **A** TPYE [10색상]

 재현8 백색	 재현290 스노우크림	 재현10 블랑쉬오크	 재현12 스킨필
 재현13 크림털시디(카로/세로결)	 재현56 씬더오크	 재현63 로잔엘름	 재현75 아이비201
 재현82 마리보오크	 재현184 다크그레이		

재고운영 색상 **B** TPYE [9색상]

 재현291 순백색	 재현217 G유백색	 재현64 블랙	 재현67 그레이
 재현229 프러시안블루	 재현230 오리엔탈블루	 재현272 샌드화이트	 재현273 샌드그레이
 재현197 화이트그레이			

- A 타입 재고 운영(재현8, 재현10, 재현12, 재현13, 재현56, 재현63, 재현75, 재현82, 재현184, 재현290)
- A 타입 부분재고 운영(재현9)
- B 타입 재고 운영(재현64, 재현67, 재현217, 재현229, 재현230, 재현272, 재현273, 재현291)

A 타입 10색상

구분	색상 코드	규격	A-TYPE									
			8	10	12	13	56	63	75	82	184	290
			백색	블랑쉬오크	스킨펄	크림펄시다	샌더오크	로잔얼름	아이비201	마리보오크	다크그레이	스노우크림
천정몰딩	JC-4	12X80	●	●	●	●	●	●	●	●	●	●
	JC-5	12X70	●	●	●	●	●	●	●	●	●	●
	JC-6	12X55	●	●	●	×	●	×	●	×	×	×
	JC-11	15X110	×	×	×	×	×	×	×	×	×	×
	JC-12	12X90	●	×	×	×	×	×	×	×	×	×
계단몰딩	JC-7	30X75	×	×	×	×	×	×	×	×	×	×
	JC-8	15X70	●	×	×	×	×	×	×	×	×	×
	JC-14	15X48	●	×	×	×	×	×	×	×	×	×
	JC-17	12X50	●	●	●	●	●	●	●	●	●	●
	JC-18	15X35	●	●	●	●	●	●	●	●	●	●
걸레받이	JS-1	9X90	●	●	●	●	●	●	●	●	●	●
	JS-2	9X60	●	×	●	×	×	×	×	×	×	●
	JS-3	9X40	●	×	×	×	×	×	×	×	×	×
	JS-8	9X80	●	●	●	●	●	●	●	●	●	●
	JS-10	15X80	●	×	×	×	×	×	×	●	×	×
문선몰딩	JM-1	12X58	×	×	×	×	×	×	×	×	×	×
	JM-3	12X60	●	●	●	●	●	●	●	●	●	●
	JM-4	9X70	×	×	×	×	×	×	×	×	×	×
	JM-6	15X40	×	×	×	×	×	×	×	×	×	×
	JM-11	12X40	●	×	●	×	×	×	×	×	×	●
마감몰딩	JF-1	12X46	×	×	×	×	×	×	×	×	×	×
	JF-2	20X22	×	×	×	×	×	×	×	×	×	×
	JF-3	12X80	●	●	●	●	●	●	●	●	●	●
	JF-7	9X80	×	×	×	×	×	×	×	×	×	×
	JL-2JL-	9X240	●	●	●	●	●	●	●	●	●	●
루바	JL-3	9X380	●	●	●	●	●	●	●	●	●	●
	JL-5	6X100	×	×	×	×	×	×	×	×	×	×
	JL-6	6X240	×	×	×	×	×	×	×	×	×	×
	JN-1	12X100	●	●	●	●	●	●	●	●	●	●
코너기둥	JN-2	12X65	●	●	●	●	●	●	●	●	●	●
	JN-3	9X40	●	●	●	●	●	●	●	●	●	●
	JR-1	원기둥	×	×	×	×	×	×	×	×	×	×
평몰딩	JW-3	허리몰딩	×	×	×	×	×	×	×	×	×	×
	JX-1	9X40	●	●	●	●	●	●	●	●	●	●
	JX-2	9X60	●	●	●	●	●	●	●	●	●	●
	JX-3	9X80	●	●	●	●	●	●	●	●	●	●
	JX-4	9X100	●	●	●	●	●	●	●	●	●	●
	JX-5	9X120	●	●	●	●	●	●	●	●	●	●
	JX-6	9X160	●	●	●	●	●	●	●	●	●	●
	JX-7	9X200	●	●	●	●	●	●	●	●	●	●
	JX-8	9X250	●	●	●	×	●	×	×	×	×	×
	JX-9	9X300	●	●	●	●	●	●	●	●	●	●
	JX-10	9X400	●	●	●	●	●	●	●	●	●	●
	JX-11	9X30	●	●	●	●	●	●	●	●	●	●
	JX-12	9X600	×	×	×	×	×	×	×	×	×	×
JX-13	9X50	×	×	×	×	×	×	×	×	×	×	

● : 재고운영색상 × : 주문운영색상











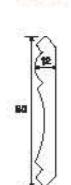



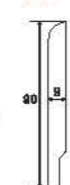



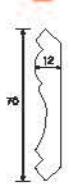



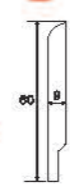



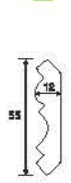



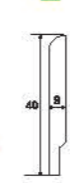

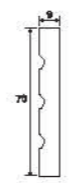

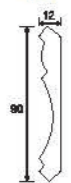

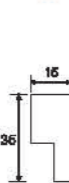





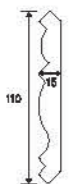

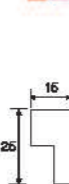

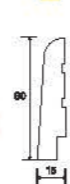
B 타입 9색상

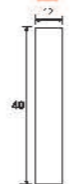







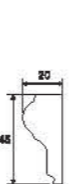







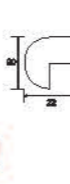

구분	색상 코드	규격	B-TYPE								
			64	67	217	229	230	272	273	291	197
			블랙	그레이	G유백색	프러시안블루	오리엔탈블루	샌드화이트	샌드그레이	순백색	하이트그레이
천정몰딩	JC-4	12X80	●	●	●	●	●	●	●	●	●
	JC-5	12X70	×	×	×	×	×	×	×	×	×
	JC-6	12X55	×	×	×	×	×	×	×	×	×
	JC-11	15X110	×	×	×	×	×	×	×	×	×
	JC-12	12X90	×	×	×	×	×	×	×	×	×
계단몰딩	JC-7	30X75	×	×	×	×	×	×	×	×	×
	JC-8	15X70	×	×	×	×	×	×	×	×	×
	JC-14	15X48	×	×	×	×	×	×	×	×	×
	JC-17	12X50	×	×	×	×	×	×	×	×	×
	JC-18	15X35	×	×	×	×	×	×	×	×	×
걸레받이	JS-1	9X90	×	×	×	×	×	×	×	×	×
	JS-2	9X60	×	×	×	×	×	×	×	×	×
	JS-3	9X40	×	×	×	×	×	×	×	×	×
	JS-8	9X80	●	●	●	●	●	●	●	●	●
	JS-10	15X80	×	×	×	×	×	×	×	×	×
문선몰딩	JM-1	12X58	×	×	×	×	×	×	×	×	×
	JM-3	12X60	●	●	●	●	●	●	●	●	●
	JM-4	9X70	×	×	×	×	×	×	×	×	×
	JM-6	15X40	×	×	×	×	×	×	×	×	×
	JM-11	12X40	×	×	×	×	×	×	×	×	×
마감몰딩	JF-1	12X46	×	×	×	×	×	×	×	×	×
	JF-2	20X22	×	×	×	×	×	×	×	×	×
	JF-3	12X80	×	×	×	×	×	×	×	×	×
	JF-7	9X80	×	×	×	×	×	×	×	×	×
	JL-2JL-	9X240	×	×	×	×	×	×	×	×	×
루바	JL-3	9X380	×	×	×	×	×	×	×	×	×
	JL-5	6X100	×	×	×	×	×	×	×	×	×
	JL-6	6X240	×	×	×	×	×	×	×	×	×
	JN-1	12X100	×	×	×	×	×	×	×	×	×
코너기둥	JN-2	12X65	×	×	×	×	×	×	×	×	×
	JN-3	9X40	×	×	×	×	×	×	×	×	×
	JR-1	원기둥	×	×	×	×	×	×	×	×	×
평몰딩	JW-3	허리몰딩	×	×	×	×	×	×	×	×	×
	JX-1	9X40	●	●	●	●	●	●	●	●	●
	JX-2	9X60	●	●	●	●	●	●	●	●	●
	JX-3	9X80	●	●	●	●	●	●	●	●	●
	JX-4	9X100	●	●	●	●	●	●	●	●	●
	JX-5	9X120	×	×	×	×	×	×	×	×	×
	JX-6	9X160	×	×	×	×	×	×	×	×	×
	JX-7	9X200	●	●	●	●	●	●	●	●	●
	JX-8	9X250	×	×	×	×	×	×	×	×	×
	JX-9	9X300	●	●	●	●	●	●	●	●	●
	JX-10	9X400	×	×	×	×	×	×	×	×	×
	JX-11	9X30	●	●	●	●	●	●	●	●	●
	JX-12	9X600	×	×	×	×	×	×	×	×	×
JX-13	9X50	×	×	×	×	×	×	×	×	×	

● : 재고운영색상 × : 주문운영색상

WRAPPING MOULDINGS 래핑 몰딩

· 시트지 패턴 특성상 재단부위에 따른 색상차가 있을 수 있습니다. (예시: 재현8, 재현75, 재현82)
 · Lot별 생산에 따른 MDF 색상차는 시트지 이색을 유발하며 해당건은 제품하자의 사유에 해당되지 않습니다.

천정몰딩  JC-4 (12×80) 10EA/단 	계단몰딩  JC-8 (15×70) 10EA/단 	걸레받이  JS-1 (9×90) 10EA/단 	문선몰딩  JM-1 (15×58) 10EA/단 주문생산 
 JC-5 (12×70) 10EA/단 	 JC-14 (15×48) 20EA/단 	 JS-2 (9×60) 10EA/단 주문생산 	 JM-3 (12×60) 10EA/단 
 JC-6 (12×55) 20EA/단 	 JC-17 (12×50) 10EA/단 	 JS-3 (9×40) 10EA/단 	 JM-4 (9×70) 10EA/단 주문생산 
 JC-12 (12×90) 10EA/단 	 JC-18 (15×35) 20EA/단 	 JS-8 (9×80) 10EA/단 	연동도어문선  JM-6 (15×40) 10EA/단 주문생산 
 JC-11 (15×110) 10EA/단 주문생산 	마이너스 몰딩  JC-19 (15×25) 20EA/단 	 JS-10 (15×80) 10EA/단 	 JM-11 (12×40) 10EA/단 
 JC-7 (30×75) 10EA/단 주문생산 	 JC-13 (20×45) 10EA/단 주문생산 	 JS-11 (15×70) 10EA/단 주문생산 	 JM-13 (20×45) 10EA/단 주문생산 

마감재  JF-1 (12×46) 10EA/단 주문생산 	루바  JL-2 (9×240) 5EA/단 	코너기둥  JN-1 (12×100×100) 3EA/단 JN-2 (12×65×65) 5EA/단 JN-3 (9×40×40) 10EA/단
 JF-2 (20×22) 10EA/단 주문생산 	 JL-3 (9×380) 2EA/단 	
 JF-3 (12×80) 10EA/단 	 JL-5 (6×100) 10EA/단 주문생산 	
 JF-7 (9×80) 10EA/단 주문생산 	 JL-6 (6×240) 10EA/단 주문생산 	
허리몰딩  JW-3 (12×80) 10EA/단 주문생산 		



· 시트지 패턴 특성상 재단부위에 따른 색상차가 있을 수 있습니다. (예시:재현10,재현11)
· Lot별 생산에 따른 MDF색상차는 시트지이색을 유발하며 해당건은 제품하자의 사유에 해당되지 않습니다.

방염몰딩 (주문생산)



평몰딩

- JFX-2 [9×60] 10EA/단
- JFX-3 [9×80] 10EA/단
- JFX-4 [9×100] 10EA/단
- JFX-5 [9×120] 10EA/단
- JFX-7 [9×200] 5EA/단
- JFX-8 [9×250] 5EA/단
- JFX-9 [9×300] 5EA/단
- JFX-10 [9×400] 5EA/단
- JFX-12 [9×600] 2EA/단

결레반이

- JFS-1 [9×90] 10EA/단



루바

- JFL-2 [9×240] 5EA/단
- JFL-3 [9×380] 5EA/단

평몰딩



- JX-1 [9×40] 20EA/단 **A B**
- JX-2 [9×60] 10EA/단 **A B**
- JX-3 [9×80] 10EA/단 **A B**
- JX-4 [9×100] 10EA/단 **A B**
- JX-5 [9×120] 10EA/단 **A**
- JX-6 [9×160] 5EA/단 **A**
- JX-7 [9×200] 5EA/단 **A B**
- JX-8 [9×250] 5EA/단 **A**
- JX-9 [9×300] 2EA/단 **A B**
- JX-10 [9×400] 2EA/단 **A**
- JX-11 [9×30] 20EA/단 **A B**
- JX-12 [9×600] 2EA/단 <주문생산>
- JX-13 [9×50] 20EA/단 <주문생산>

방염 래핑 몰딩

소방법 개정에 따라 공공장소·다중이용매장·관공서 등에서는 불연마감재 사용이 의무화 되었습니다.
재현하늘창 방염 래핑 몰딩은 한국소방검정공사의 엄격한 테스트에 합격한 제품입니다.
우수한 방염성능으로 유해가스 발생이 적고 비교적 불에 잘 타지않는 안전성을 보장합니다.

방염 래핑 몰딩 주문방법



시험 성적서



·본 시험성적서는 방염값을 더산 하지 않습니다.

방염처리된 제품의 화재 실험



일반제품 (화재 120초 후) 방염된 재현하늘창 제품 (화재 120초 후)

시험항목	기준	시험결과		
		1	2	3
잔염시간	10초이내	0.0초	0.0초	0.0초
잔신시간	30초이내	0.0초	0.0초	0.0초
탄화면적	50cm ² 이내	22,3cm ²	26,0cm ²	22,3cm ²
탄화길이	20cm이내	6,6cm	7,1cm	7,0cm

방염성능 TEST 결과

·비정기적으로 한국소방검정공사의 연기민도 검사에 적용되는 제품은 납기가 지연될 수 있습니다.
·빠른 납기를 원할 경우 방염인테리어 필름으로 대체가 가능합니다. (시트지 추가비용 발생)

방염 인테리어 필름 도어 / 문틀

방염 인테리어 필름 시험성적서

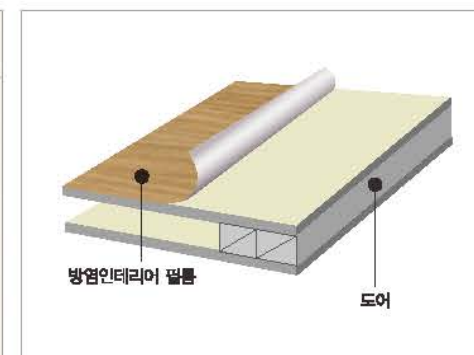

방염 인테리어 필름(50m 운영)



·방염인테리어 필름으로 사용안도어/문틀은 방염값이 부착되지 않습니다. 방염도어 시험성적서기 이는 방염인테리어 필름에 더한 시험성적서만 고부기 가능합니다.

PVC 몰딩

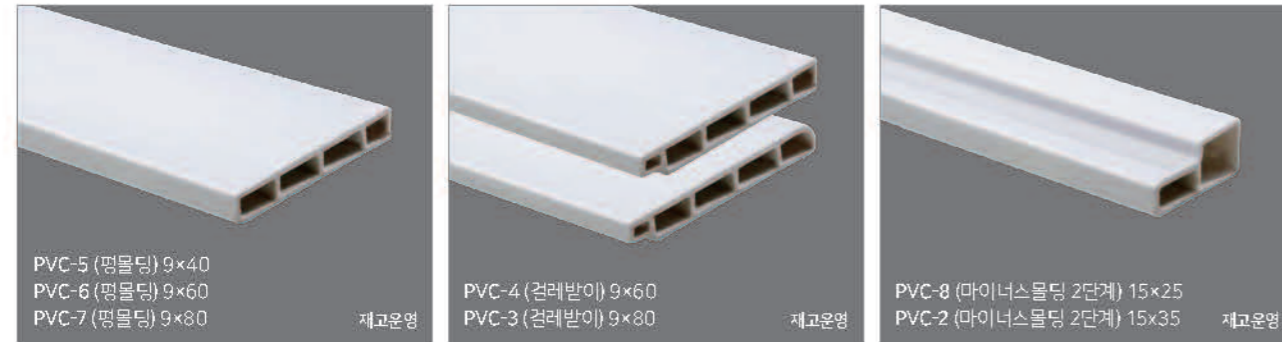

▶ 래핑제품은 주문생산 합니다.

백색페이퍼(도장용)몰딩



[백색페이퍼 평판 재고 운영규격]
 JX-1 (9x40)
 JX-2 (9x60)
 JX-3 (9x80)

PVC 도어 프레임 캐치홈 옵션 발주시 주의사항
 - 캐치홈 가공 발주시 식유는 틀 중앙 가공이 기본이며 식무일 경우는 당기는 문 기준으로

① 좌경첩(LH)인지 우경첩(RH)인지
 ② 문짝 높이 지정
 ③ 실린더홈 위치가 필요합니다.

예시) PVC 도어 프레임 140mmX900mmX2100mm 식무일 경우
 ① 우경첩(RH)
 ② 문짝 높이 2060mm
 ③ 실린더홈 하단기준 950지점

가스켓 운영 색상

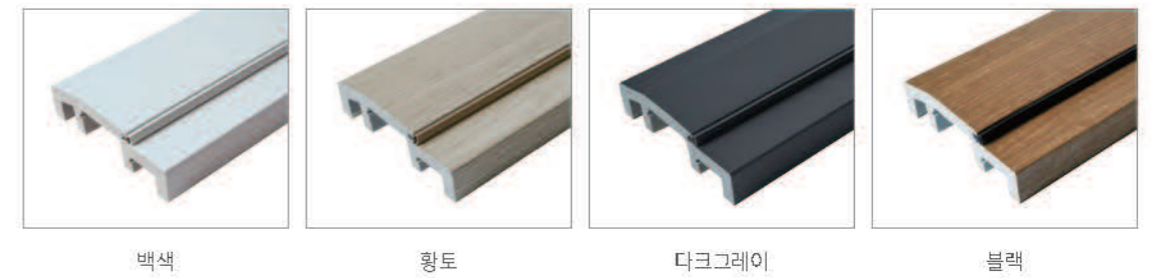

가스켓 운영 색상 조건표

A 타입 10색상 B 타입 9색상

시트타입	A-TYPE										B-TYPE								
	R	10	12	13	56	63	75	87	184	290	64	67	217	228	230	272	273	291	197
시트명칭	버셔	날랑쉬 오그	스킨립	그린립 시디	샌더 오그	로진 갈음	이더비 201	미리보 오그	디그 그레이	스노우 그린	블랙	그레이	G 유버셔	프러시 약탈루	오리엔 탈탈루	샌드 화이트	샌드 그레이	순버셔	하이트 그레이
백색	○		○	○		○	○			○			○					○	○
황토		●			●			●											
다크그레이									●			●					●		
블랙										●	●		●	●					

※ 재고운영 색상 외 별도 지정 없을 시 당시 지정으로 출고합니다.

PVC 도어 프레임 운영 조건표

A 타입 10색상 B 타입 9색상

시트타입	A-TYPE										B-TYPE								
	R	10	12	13	56	63	75	87	184	290	64	67	217	228	230	272	273	291	197
시트명칭	버셔	날랑쉬 오그	스킨립	그린립 시디	샌더 오그	로진 갈음	이더비 201	미리보 오그	디그 그레이	스노우 그린	블랙	그레이	G 유버셔	프러시 약탈루	오리엔 탈탈루	샌드 화이트	샌드 그레이	순버셔	하이트 그레이
110mm	●	●	●	●	●	●	●	●	●	●	●	●	●	●	●	●	●	●	●
130mm	●	●	●	●	●	●	●	●	●	●	●	●	●	●	●	●	●	●	●
140mm	●	●	●	●	●	●	●	●	●	●	●	●	●	●	●	●	●	●	●
155mm	●	●	●	●	●	●	●	●	●	●	●	●	●	●	●	●	●	●	●
175mm	●	●	●	●	●	●	●	●	●	●	●	●	●	●	●	●	●	●	●
195mm	●	●	●	●	●	●	●	●	●	●	●	●	●	●	●	●	●	●	●
210mm	●	●	●	●	●	●	●	●	●	●	●	●	●	●	●	●	●	●	●
230mm	●	●	●	●	●	●	●	●	●	●	●	●	●	●	●	●	●	●	●
245mm	●	●	●	●	●	●	●	●	●	●	●	●	●	●	●	●	●	●	●

● : A-TYPE 재고운영색상 ● : B-TYPE 재고운영색상 × : 주문운영색상

가스켓형



오메가 레일형



PVC 일체형 레일
은영색상(3색상)



WOODEN DOOR FRAMES 목재 도어 프레임

목재 도어 프레임은 엄선된 원목 집성목, MDF 등에 다양한 시트지를 래핑하여 다채로운 색감의 연출이 가능합니다.

래핑 분리형 문틀

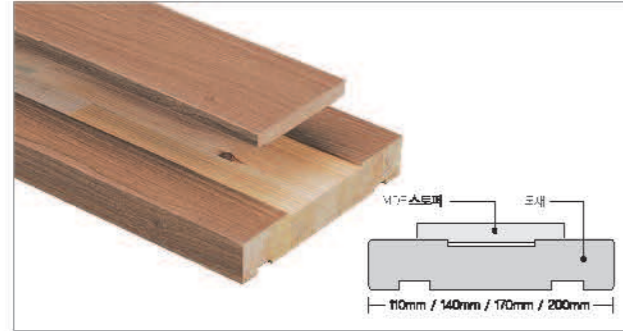

래핑 분리형 문틀의 최소폭은 70mm(비대칭), 최대폭은 320mm(소재 아음작업)입니다.

래핑 일체형 문틀

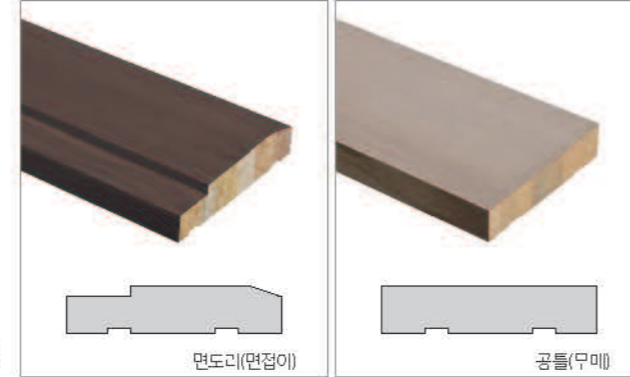

래핑 분리형 가스켓 문틀

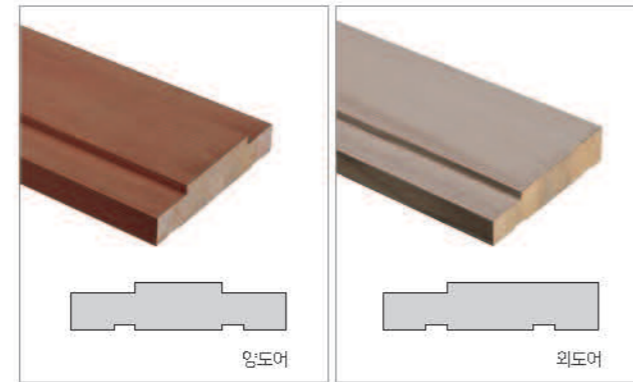
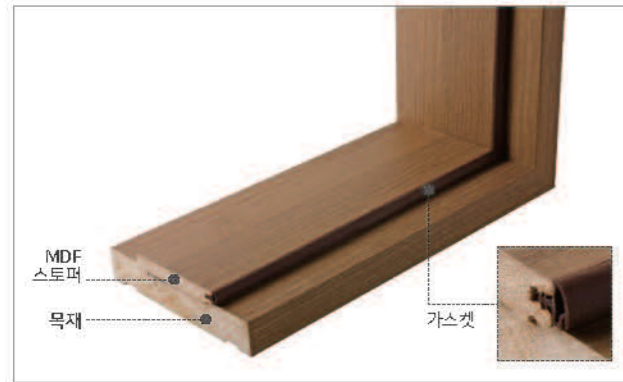

래핑 일체형 문틀의 최소폭은 70mm(외도어), 최대폭은 240mm(외도어, 양도어, 면접이)입니다.

래핑 미서기 창틀

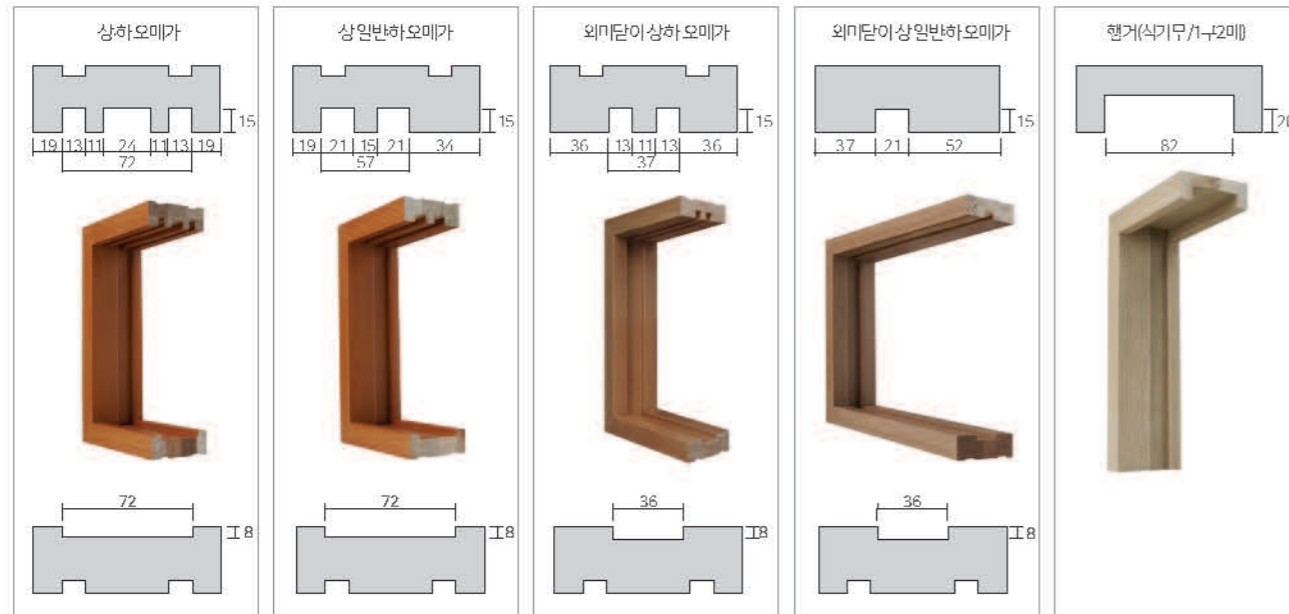

래핑 창틀 사이즈는 틀 외경이 기준이며 1구 2매, 1구 3매(레인홀 2홀, 3홀), 1구 4매, 1구 6매 표기가 필요합니다.

포켓 창틀은 외미달이형(식유, 오메가 레인 사용), 행거 레인형(식무)이 있습니다.

1구 2매용 틀(33mm 도어용)은 최소폭 100mm까지 가능합니다.

1구 1매용 틀(33mm 도어용)은 최소폭 70mm까지 가능합니다.

PVC CAP ASSEMBLED DOOR FRAMES PVC 캡가변형 문틀

MOULDINGS & DOOR FRAMES

가문틀 방식으로 현장 스크래치를 예방하며, 크랙 및 뒤틀림이 적고 시공 후 재설치가 용이합니다.

전계품 가스켓 분리형 문틀로 변경 가능합니다.(음 선사형) 가스켓



시공 전 입체도

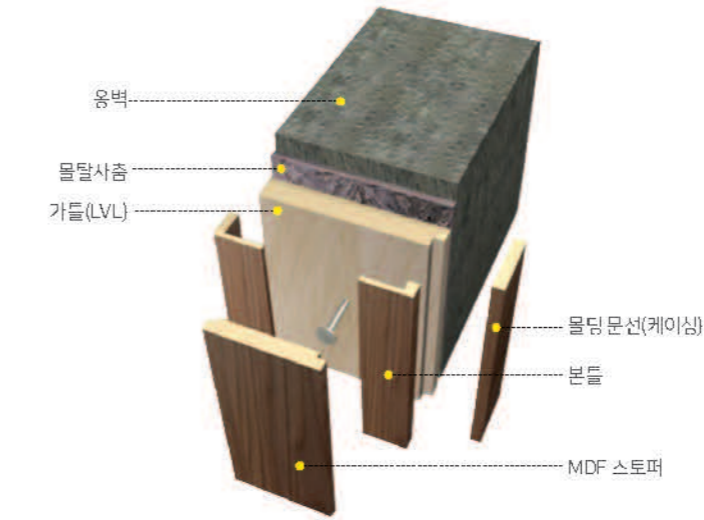

시공 후 입체도

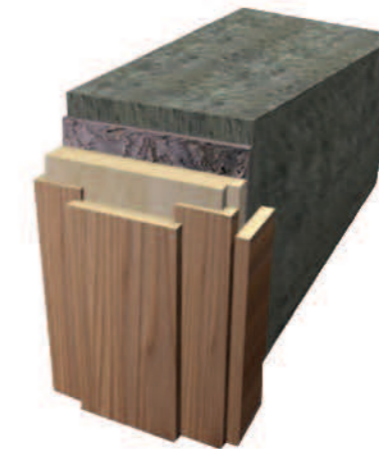

A형:일면문선

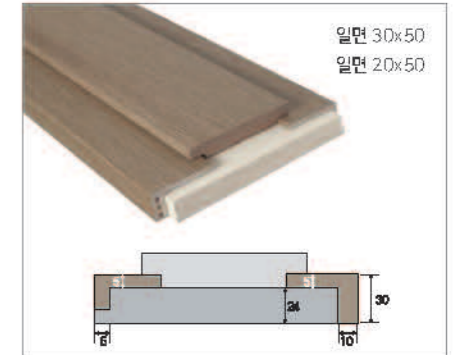

B형:캡마감

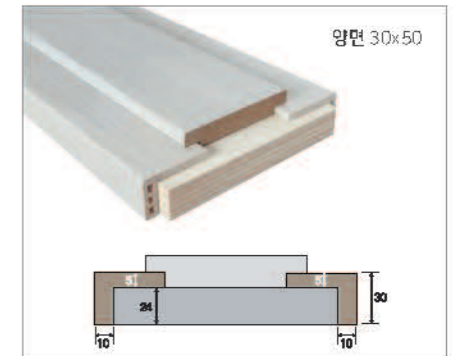

C형:양면문선



D형:일면 도어 하우스징

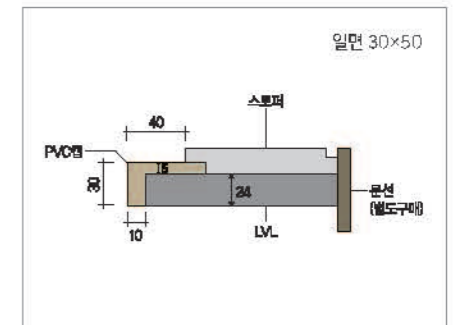

문틀 제작(사이수) 계산표

규격(mm)	4방틀(식유)	3방틀(식무)	규격(mm)	4방틀(식유)	3방틀(식무)
110×1000×2100	11.0	9.0	170×1000×2100	15.0	13.5
110×900×2100	10.0	8.5	170×900×2100	15.0	12.75
110×800×2100	10.0	8.5	170×800×2100	15.0	12.75
140×1000×2100	13.75	11.25	200×1000×2100	19.25	15.75
140×900×2100	12.5	10.63	200×900×2100	17.5	14.88
140×800×2100	12.5	10.63	200×800×2100	17.5	14.88